

# VT8000 Room Controllers

## VZ8250 Installation Guide

Variable Air Volume (VAV) Unit

Firmware Revision 2.5.1



## TABLE OF CONTENTS

1. SAFETY INFORMATION.....	3
2. INSTALLATION .....	6
3. TYPICAL APPLICATION: PRESSURE INDEPENDENT (NO FAN).....	7
4. TYPICAL APPLICATION: PRESSURE INDEPENDENT (PARALLEL FAN) .....	8
5. TYPICAL APPLICATION: PRESSURE DEPENDENT (NO FAN) .....	9
6. TERMINAL IDENTIFICATION .....	10
7. HOME SCREEN DISPLAY .....	13
8. HOW TO ENTER SET-UP SCREEN .....	14
9. SET-UP SCREEN DISPLAY .....	14
10. BALANCING .....	15
APPENDIX A. DEPLOYMENT .....	21
APPENDIX B. CALIFORNIA PROPOSITION 65 WARNING STATEMENT FOR CALIFORNIA RESIDENTS....	24

## 1. SAFETY INFORMATION

### 1.1 IMPORTANT INFORMATION

Read these instructions carefully and inspect the equipment to become familiar with the device before trying to install, operate, service or maintain it. The following special messages may appear throughout this bulletin or on the equipment to warn of potential hazards or to call attention to information that clarifies or simplifies a procedure.

 The addition of this symbol to a “Danger” or “Warning” safety label indicates that an electrical hazard exists which will result in personal injury if the instructions are not followed.

 This is the safety alert symbol. It is used to alert you to potential personal injury hazards. Obey all safety messages that follow this symbol to avoid possible injury or death.

#### **DANGER**

**DANGER** indicates a hazardous situation which, if not avoided, **will result in** death or serious injury.

#### **WARNING**

**WARNING** indicates a hazardous situation which, if not avoided, **could result in** death or serious injury.

#### **CAUTION**

**CAUTION** indicates a hazardous situation which, if not avoided, **could result in** minor or moderate injury.

#### **NOTICE**

NOTICE is used to address practices not related to physical injury. The safety alert symbol shall not be used with this signal word.

### 1.2 PLEASE NOTE

Electrical equipment should be installed, operated, serviced, and maintained only by qualified personnel. No responsibility is assumed by Viconics Technologies for any consequences arising out of the use of this material.

A qualified person is one who has skills and knowledge related to the construction, installation, and operation of electrical equipment and has received safety training to recognize and avoid the hazards involved.

## 1.3 BEFORE YOU BEGIN

### LOSS OF CONTROL

#### ⚠ WARNING

##### LOSS OF CONTROL

- The designer of any control scheme must consider the potential failure modes of control paths and, for certain critical control functions, provide a means to achieve a safe state during and after a path failure. Examples of critical control functions are emergency stop and over travel stop.
- Separate or redundant control paths must be provided for critical control functions.
- System control paths may include communication links. Consideration must be given to the implications of anticipated transmission delays or failures of the link.<sup>1</sup>
- Each implementation of equipment utilizing communication links must be individually and thoroughly tested for proper operation before being placed into service.

**Failure to follow these instructions can result in death, serious injury, or equipment damage.**

### ELECTROSTATIC DISCHARGE

#### NOTICE

##### STATIC SENSITIVE COMPONENTS

Circuit boards and option cards can be damaged by static electricity. Observe the electrostatic precautions below when handling controller circuit boards or testing components.

**Failure to follow these instructions can result in equipment damage.**

Observe the following precautions for handling static-sensitive components:

- Keep static-producing material such as plastic, upholstery, and carpeting out of the immediate work area.
- Store static-sensitive components in protective packaging when they are not installed in the drive.
- When handling a static-sensitive component, wear a conductive wrist strap connected to the component or drive through a minimum of 1 megohm resistance.
- Avoid touching exposed conductors and components leads with skin or clothing.

### INSTALLATION

#### NOTICE

##### INSTALLATION

- The system must be installed correctly by a qualified technician.
- If replacing an existing Room Controller, label wires before removal of the Controller.
- Electronic controls are static sensitive devices. Discharge yourself correctly before manipulating and installing Room Controller.
- A short circuit or wrong wiring may permanently damage the Room Controller or equipment.
- All Room Controllers are designed for use as operating controls only and are not safety devices. Tampering with the devices or unintended application of the devices will result in a void of warranty.
- This device must be installed to provide a separation distance of at least 8in (20cm) from all persons and must not be located or operating in conjunction with any other antenna or transmitter.
- Refer to the Room Controller User Interface Guide for information on how to configure the Room Controller.

**Failure to follow these instructions can result in equipment damage.**

<sup>1</sup> For additional information about anticipated transmission delays or failures of the link, refer to NEMA ICS 1.1 (latest edition), *Safety Guidelines for the Application, Installation, and Maintenance of Solid State Control* or its equivalent

## UNAUTHORIZED USB ACCESS

### NOTICE

#### UNAUTHORIZED USB ACCESS

To prevent unauthorized access to the Room Controller via USB, it is recommended that:

- "USB access" is set to "Disabled" to prevent changing of firmware, standby image, configuration or LUA scripts via USB.
- "Main password" is set to a non-zero value to limit configuration menu access to authorized users only.

**Failure to follow these instructions may lead to unauthorized users modifying the firmware or the configuration of the Room Controller.**

## LOCATION

### NOTICE

#### LOCATION

- Do not install on an exterior wall.
- Do not install behind a door.
- Do not install in areas with a direct heat source.
- Do not install near any air discharge grill.
- Do not install in areas exposed to direct sunlight.
- Ensure the Room Controller has sufficient natural air circulation.
- Ensure the wall surface is flat and clean.
- Ensure external thermal sensor wirings are away from noisy electrical sources.
- Install 1.3 to 1.5 meters (52 to 60 inches) above the floor.
- Perform preventive maintenance on the damper and Variable Air Volume (VAV) box, according to the supplier documentation.

**Failure to follow these instructions can result in equipment damage.**

## CLEANING THE ROOM CONTROLLER

### NOTICE

#### CLEANING THE ROOM CONTROLLER

- Use a soft, pre-moistened lint-free cloth for cleaning.
- Avoid getting moisture in openings.
- Do not spray anything directly on the Room Controller or use compressed air.
- Do not use caustic/corrosive products, ammonia, solvents or any cleaning product containing alcohol or grit.
- Never use tools directly on the touchscreen.
- Never use paint on the Room Controller.
- Do not drop or crush the Room Controller, or allow it to come into contact with liquids.
- Do not use a damaged device (such as one with a cracked screen).

**Failure to comply with these recommendations will result in damage to the unit and void the manufacturer's warranty.**

## 2. INSTALLATION

1. Remove the security screw (if applicable) from the bottom of the Room Controller cover.
2. Open the unit by pulling on the bottom side of the Room Controller (Figure 1).
3. Read the FCC ID and IC label installed inside the cover before installing any wireless product.
4. Ensure the correct side of the base faces up.
5. Pull the cables 6in (15cm) out from the wall.
6. Align the base and mark the location of the two mounting holes on the wall.
7. Install the anchors in the wall (Figure 2).
8. Insert the cable in the central hole of the base.
9. Insert the screws in the mounting holes on each side of the base.
10. Strip each wire 1/4in (0.6cm) from the end.
11. Insert each wire and screw according to the wiring chart (see following pages).
12. Gently push excess wiring back into the hole.
13. Gently align the cover with the top of the base and snap it into place from the bottom (Figure 3).
14. Install the security screw (if applicable).

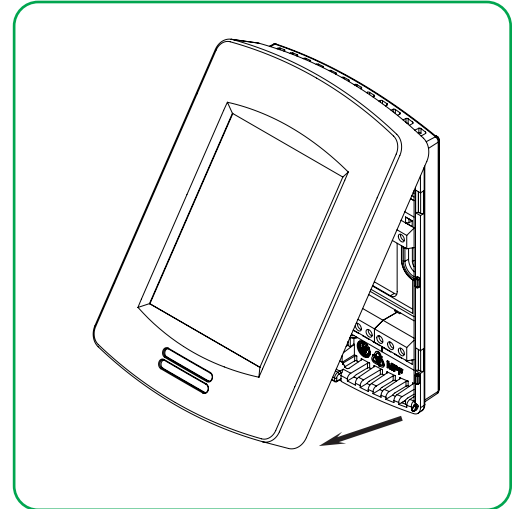

Figure-1 Open the cover

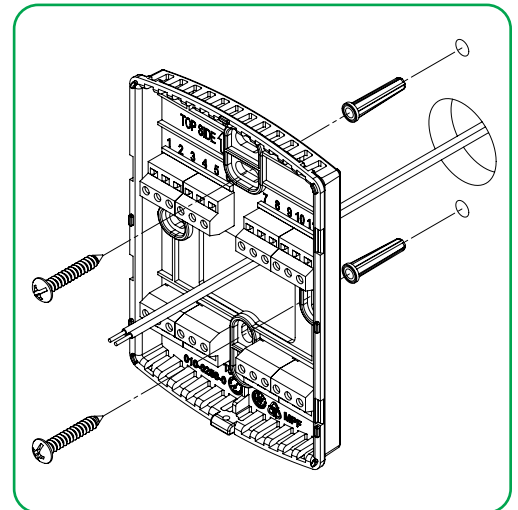

Figure-2 Install the base

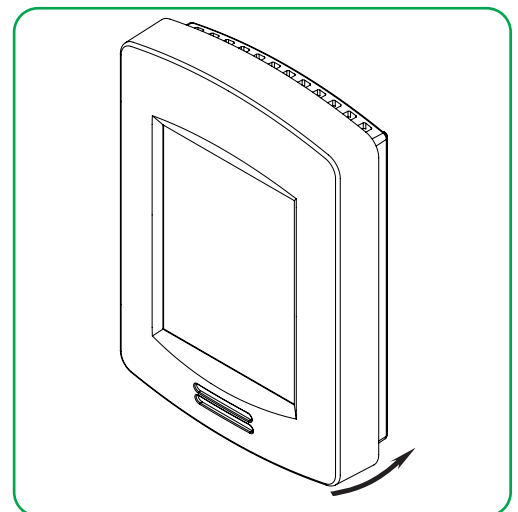
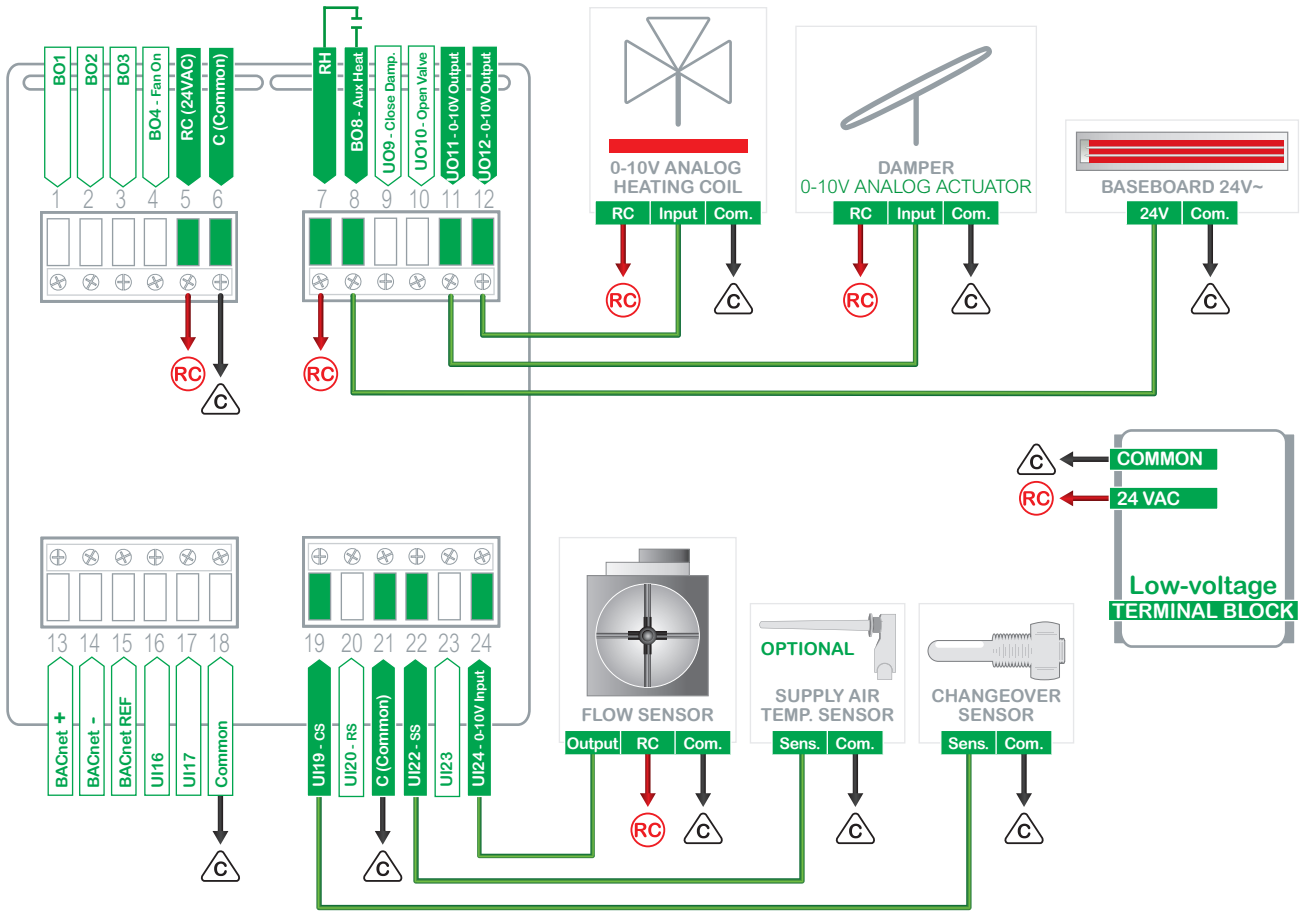

Figure-3 Reinstall cover

### 3. TYPICAL APPLICATION: PRESSURE INDEPENDENT (NO FAN)

#### 0-10V Analog Control



Configuration Parameter Name	Configuration Settings
VAV box type	PI
Actuator type	0-10V DA
Fan type	None
Reheat configuration	Duct + baseboard
Duct heater	0-10V DA
Baseboard configuration	PWM VAC

Refer to the VZ8250 **Application Guide** for more information on the “Sequence of Operations and Wiring”.

### 4. TYPICAL APPLICATION: PRESSURE INDEPENDENT (PARALLEL FAN)

#### 0-10V Analog Control + Parallel Fan

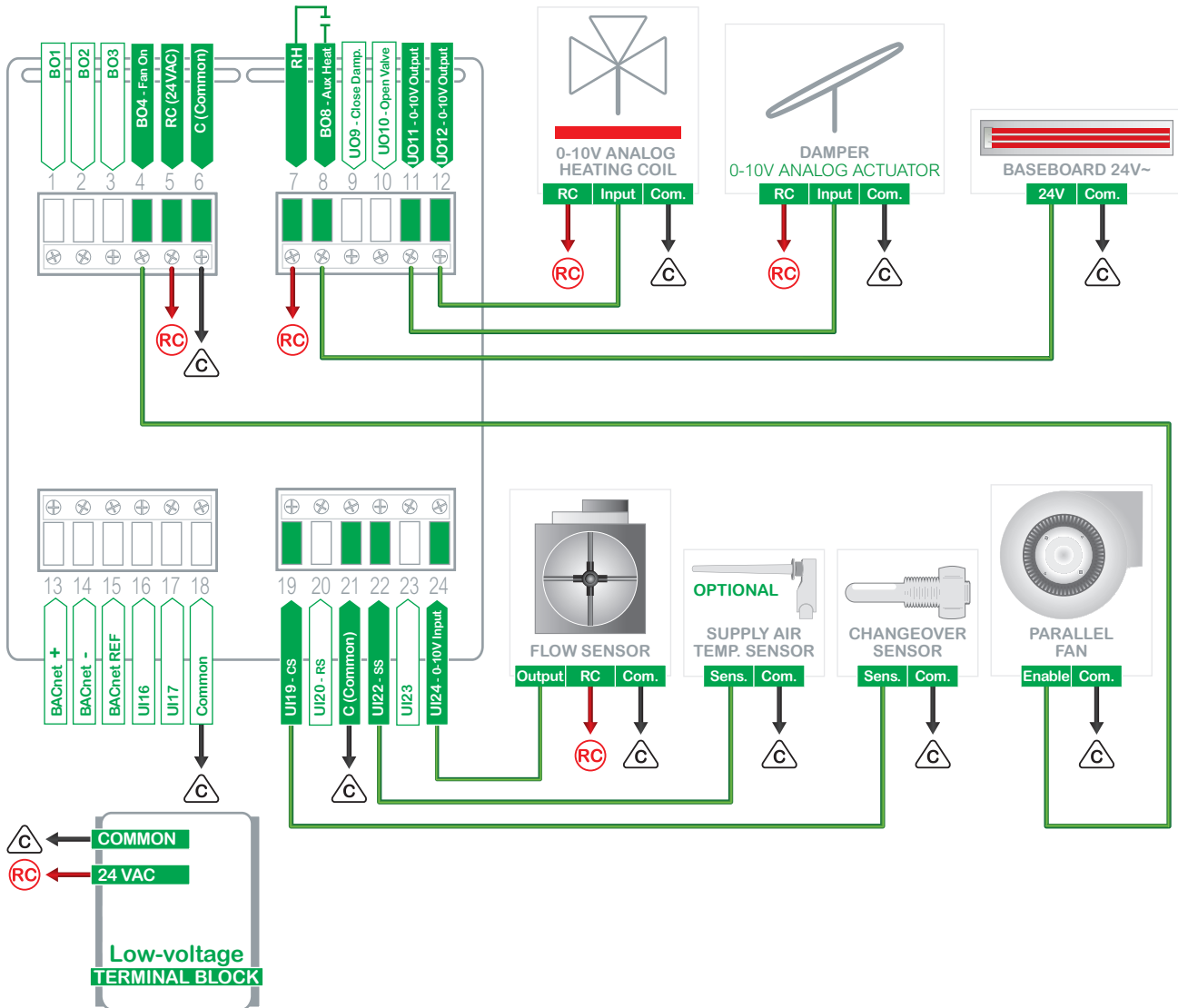

Configuration Parameter Name	Configuration Settings
VAV box type	PI
Actuator type	0-10V DA
Fan type	Parallel binary
Reheat configuration	Duct + baseboard
Duct heater	0-10V DA
Baseboard configuration	PWM VAC

Refer to the VZ8250 **Application Guide** for more information on the “Sequence of Operations and Wiring”.



### 5. TYPICAL APPLICATION: PRESSURE DEPENDENT (NO FAN)

#### Floating Control

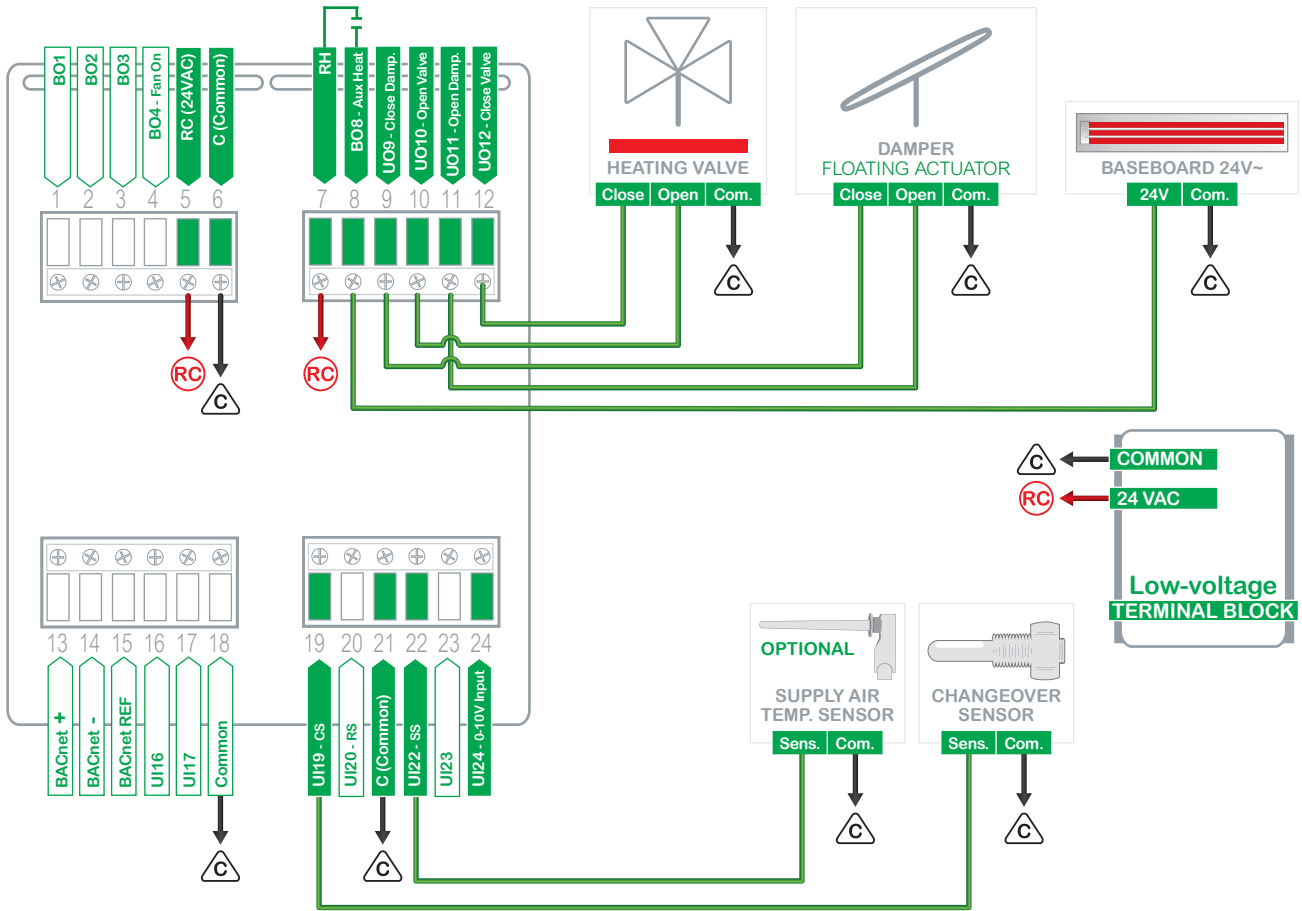

Configuration Parameter Name	Configuration Settings
VAV box type	PD
Actuator type	Floating
Fan type	None
Reheat configuration	Duct + baseboard
Duct heater	Floating
Baseboard configuration	Valve NC (Normally Closed)

Refer to the VZ8250 **Application Guide** for more information on the “Sequence of Operations and Wiring”.

## 6. TERMINAL IDENTIFICATION

### 6.1 FAN TYPE

Supported fan types:

- Parallel On/Off
- Serial On/Off
- Parallel ECM
- Serial ECM

Supported output types:

- On/Off: Binary Output
- ECM: Analog Output

Binary (24V~)		
Terminal	Name	Connection
4	BO4	24V~ Enable
6, 18 or 21	C / 24 V~ Common	24 V~ Common
ECM (0-10V DC)*		
Terminal	Name	Connection
6, 18 or 21	C / 24 V~ Common	24 V~ Common
10	UO10	0-10V Output

\* **Warning!** Floating duct reheat is not possible when Fan Type is ECM.

### 6.2 AIRFLOW SENSOR (PI ONLY)

Supported airflow sensor parameters:

- Output voltage = 0-10V (DC)
- Pressure range = 0.5 or 5-inch water column
- Flow a 1-inch water column:
  - Minimum = 10
  - Maximum = 10000

**NOTE:** Refer to the VAV box manufacturer flow chart for the recommended settings.

Recommended airflow sensor: Schneider Electric (Veris) PX3PXX01 or equivalent.

PI-Only Airflow Sensor		
Terminal	Name	Connection
5	RC / 24 V~ Hot	24 V~ Hot
6, 18 or 21	C / 24 V~ Common	24 V~ Common
24	UI24	0-10V Input

### 6.3 DAMPER

Supported output types:

- 0-10V Direct Acting
- 0-10V Reverse Acting
- 2-10V Direct Acting
- 2-10V Reverse Acting
- Floating

Recommended damper: Schneider Electric MS41-6043 or equivalent.

0-10V Analog Actuator		
Terminal	Name	Connection
5	RC / 24 V~ Hot	24 V~ Hot
6, 18 or 21	C / 24 V~ Common	24 V~ Common
11	UO11	0-10V Output
Floating Actuator*		
Terminal	Name	Connection
6, 18 or 21	C / 24 V~ Common	24 V~ Common
9	UO9	Close Actuator
11	UO11	Open Actuator

\* Floating actuation time limits:

- Minimum = 0.5 minutes
- Maximum = 9.0 minutes
- Increment = 0.5 minutes

### 6.4 CHANGEOVER & SUPPLY SENSORS

The Room Controller is compatible with remote mount temperature sensors using 10k type 2 NTC thermistors.

Changeover & Supply Sensors		
Terminal	Name	Connection
19	UI19	Changeover Sensor
6, 18 or 21	C / 24 V~ Common	24 V~ Common
22	UI22	Supply Sensor

## 6.5 REHEAT - DUCT

Supported output types:

- 0-10V Direct Acting
- 0-10V Reverse Acting
- 2-10V Direct Acting
- 2-10V Reverse Acting
- Floating
- On/Off
- PWM
- Valve NC
- Valve NO

0-10V Analog Duct Heater			
Terminal	Name	Connection	Required Settings
5	RC / 24 V~ Hot	24 V~ Hot	Duct Heater Configuration: <ul style="list-style-type: none"> <li>• 0-10V Direct Acting, or</li> <li>• 0-10V Reserve Acting</li> </ul>
6, 18 or 21	C / 24 V~ Common	24 V~ Common	
12	UO12	0-10V Output	
Floating Duct Heater			
Terminal	Name	Connection	Required Settings
6, 18 or 21	C / 24 V~ Common	24 V~ Common	Duct Heater Configuration: Floating
10	UO10	24 V~ Open Damper Actuator	
12	UO12	24 V~ Close Damper Actuator	
On/Off or PWM Duct Heater			
Terminal	Name	Connection	Required Settings
6, 18 or 21	C / 24 V~ Common	24 V~ Common	Duct Heater Configuration: <ul style="list-style-type: none"> <li>• On/Off, or</li> <li>• PWM, or</li> <li>• Valve NC, or</li> <li>• Valve NO</li> </ul>
12	UO12	24 V~ Output	

## 6.6 REHEAT - BASEBOARD

The VZ8250 controls baseboard heaters via:

- Relay = 4 CPH (Cycles Per Hour)
- PWM = 10-second duty cycle
- Valve (Normally Open or Normally Closed) = 8 CPH (Cycles Per Hour)

Supported output types:

- Relay On/Off
- PWM
- Valve NC
- Valve NO

Relay with Transformer (Dry Contact)			
Terminal	Name	Connection	Required Settings
7	RH	Room Controller Terminal 5 (24 V~)	Baseboard Reheat: Relay
8	BO8	24 V~ to Baseboard	
24V~			
Terminal	Name	Connection	Required Settings
5	RC / 24 V~ Hot	Room Controller Terminal 7 (RH)	Baseboard Reheat: <ul style="list-style-type: none"> <li>• Relay, or</li> <li>• PWM, or</li> <li>• Valve NC, or</li> <li>• Valve NO</li> </ul>
6, 18 or 21	C / 24 V~ Common	24 V~ Common	
7	RH	Room Controller Terminal 5 (24 V~)	
8	BO8	24 V~ to Baseboard	

### 7. HOME SCREEN DISPLAY

Hospitality User Interface Shown



### 8. HOW TO ENTER SET-UP SCREEN



Touch and hold this point for 3 seconds to enter set-up mode

**NOTE:** If a configuration/installer password is activated to prevent unauthorized access to the configuration menu parameters, a password entry prompt shows to prevent access to the device configuration components.

For more information on using and configuring the functions of the HMI, refer to the **VZ8250 User Interface Guide**

### 9. SET-UP SCREEN DISPLAY

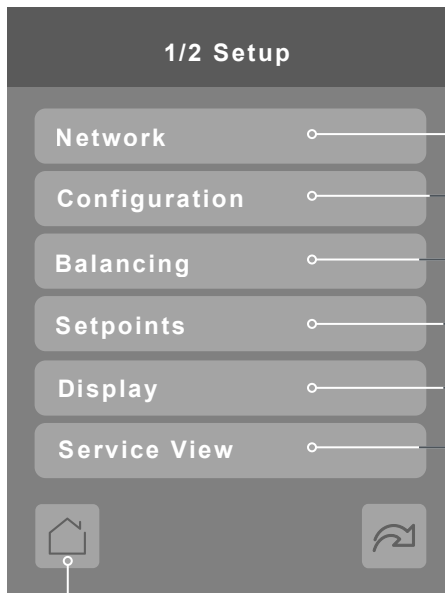

Enter BACnet® & Zigbee® network settings

Enter parameter configuration menu

Enter balancing settings

Enter setpoint settings

Enter display settings

Enter status and service view

Return to the home screen

General Note:

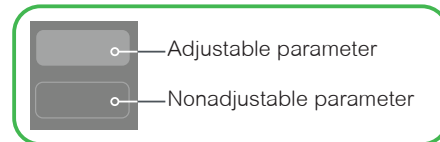

For more information on using and configuring the functions of the HMI, refer to the **VZ8250 User Interface Guide**.

## 10. BALANCING

During balancing, a technician will install a calibrated flow sensor (Balometer) over the outlet in each room and use this to calibrate the VZ8250:

- **Pressure Independent:**
  - True airflow will be measured and compared to the airflow calculated by the VZ8250 at various setpoints.
  - VZ8250 calibration parameters will be adjusted by the technician to ensure the calculated airflow matches the true airflow.
- **Pressure Dependent:**
  - True airflow at various damper percentages will be measured and used to set the appropriate damper percentages for the airflow required for the zone.

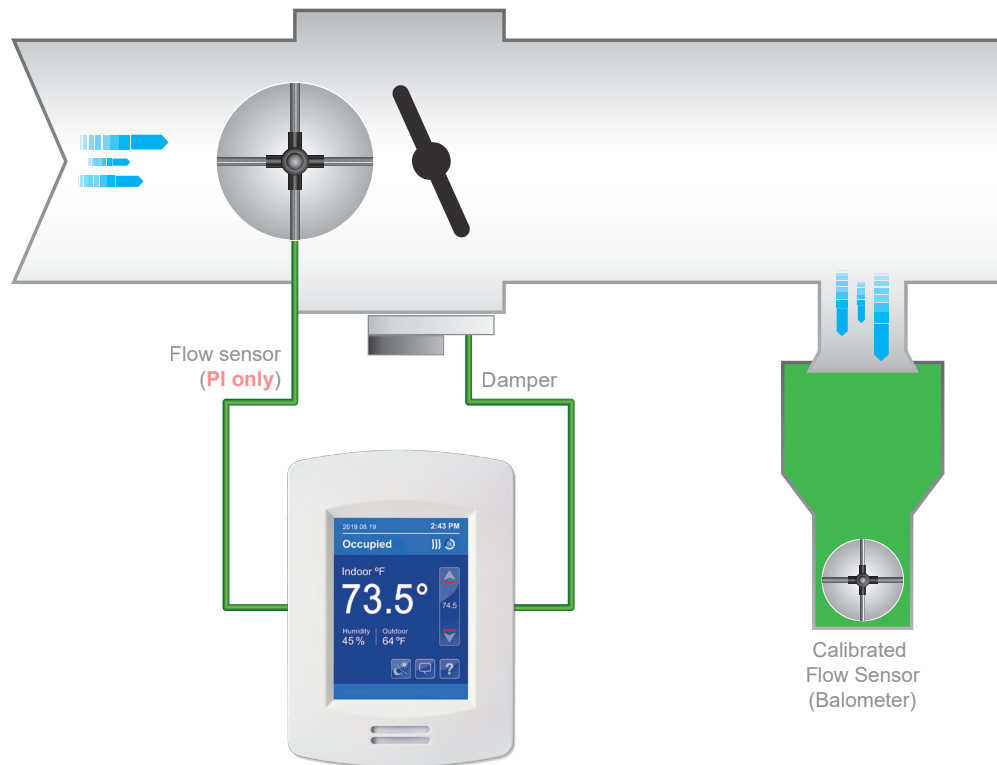

**NOTE:** Balancing menus will timeout after 8 hours and any Damper Override will be removed, returning the zone to normal operation.

## 10.1 PRESSURE INDEPENDENT

Before starting to Balance the system, check the following parameters are correctly configured in the Configuration menu:

- VAV Box Type
- Flow at 1-inch water column
- Airflow Sensor Pressure Range
- Actuator Type
- Floating Actuator Time

Airflow Balancing settings can be found on the Balancing page of the Setup menu.

The recommended process for Balancing the system is:

1. On page “1/2 Balancing (PI)”, check the Minimum, Maximum Cooling, Maximum Heating and Reheat airflow setpoints are correctly configured for the zone.
2. Check airflow sensor is correctly zeroed:
  - a. On page “2/2 Balancing (PI)”, set Damper Override to Close.
  - b. Wait for the measured “Airflow level” to stabilize and confirm the value is less than the desired Minimum Airflow. If not, confirm damper is closed and auto-zero the airflow sensor. Refer to the flow sensor Installation Guide for more information on zeroing.
3. Before setting the Minimum and Maximum Cooling airflow, make sure that when fully open, the airflow is at least 40-60 CFM higher than the planned Maximum Cooling airflow. Otherwise, the control will be erratic.

### **NOTICE**

#### **MINIMUM AND MAXIMUM COOLING AIRFLOW**

When damper is fully open, the airflow must be at least 40-60 CFM higher than the planned Maximum Cooling airflow.

**Failure to follow these instructions can result in erratic airflow control depending on the HVAC design.**

4. Calibrate sensor at Minimum airflow:
  - a. On page “2/2 Balancing (PI)”, set the Damper Override to Minimum Flow. The displayed Airflow Setpoint will use the value of Minimum Airflow.
  - b. Wait for the measured “Airflow level” of the Room Controller to stabilize.
  - c. Take a reading of the actual airflow using a calibrated Balometer.
  - d. Enter the actual airflow as the “Balometer” value on “2/2 Balancing (PI)”. The Room Controller will calculate and display a new Minimum Flow Offset.
  - e. Wait for the measured “Airflow level” to stabilize again. The Airflow level should now match the Airflow setpoint. Repeat if necessary.
5. Calibrate sensor at Maximum Cooling airflow:
  - a. On page “2/2 Balancing (PI)”, set the Damper Override to Maximum Cooling. The displayed Airflow Setpoint will use the value of Maximum Cooling Airflow.
  - b. Wait for Room Controller measured “Airflow level” to stabilize.
  - c. Take a reading of the actual airflow using a calibrated Balometer.
  - d. Enter the actual airflow as the “Balometer” value on “2/2 Balancing (PI)”.
  - e. The Room Controller will calculate and display a new Maximum Flow Offset.
  - f. Wait for the measured “Airflow level” to stabilize again. Airflow level should now match the Airflow setpoint. Repeat if necessary.
6. On page “2/2 Balancing”, revert the Damper Override to None allowing the system to return to normal operation.



## BALANCING OPTIONS

**1/2 Balancing (PI)**

Airflow level

49 CFM

Airflow setpoint

50 CFM

Min. flow

50 CFM

Max. cool flow

180 CFM

Max. heat flow

180 CFM

Reheat flow

80 CFM

Pressure Independent		
Configuration parameter	BACnet	Function description
<b>Airflow Level</b>	AV110 (R)	Measured (calibrated) airflow: <ul style="list-style-type: none"> <li>Units = CFM</li> <li>Min = 0</li> <li>Max = 20000</li> </ul>
<b>Airflow Setpoint</b>	AI350 (R)	Measured (calibrated) airflow: <ul style="list-style-type: none"> <li>Units = CFM</li> <li>Min = 0</li> <li>Max = 10000</li> </ul>
<b>Minimum Airflow</b>	AV250 (R/W)	Minimum airflow supplied to the zone: <ul style="list-style-type: none"> <li>Units = CFM</li> <li>Min = 0</li> <li>Max = 10000</li> <li>Default = 50</li> </ul>
<b>Maximum Cooling Airflow</b>	AV252 (R/W)	Maximum airflow supplied to the zone when cooling: <ul style="list-style-type: none"> <li>Units = CFM</li> <li>Min = 0</li> <li>Max = 10000</li> <li>Default = 200</li> </ul>
<b>Maximum Heating Airflow</b>	AV251 (R/W)	Maximum airflow supplied to the zone when heating: <ul style="list-style-type: none"> <li>Units = CFM</li> <li>Min = 0</li> <li>Max = 10000</li> <li>Default = 200</li> </ul>
<b>Maximum Reheat Airflow</b>	AV253 (R/W)	Maximum airflow supplied to the zone with duct reheat: <ul style="list-style-type: none"> <li>Units = CFM</li> <li>Min = 0</li> <li>Max = 10000</li> <li>Default = 50</li> </ul>

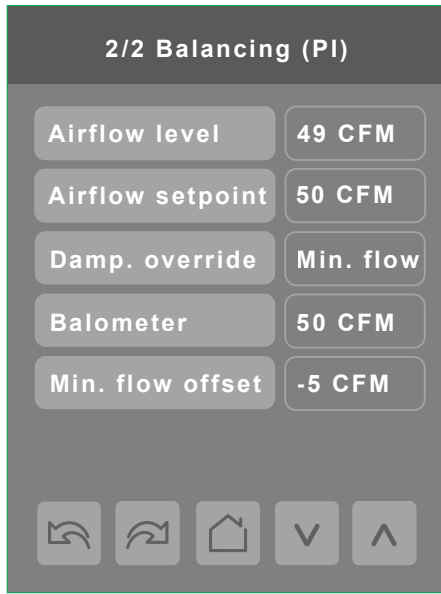

Pressure Independent		
Configuration parameter	BACnet	Function description
<b>Airflow Level</b>	AHV110 (R)	Measured (calibrated) airflow: <ul style="list-style-type: none"> <li>Units = CFM</li> <li>Min = 0</li> <li>Max = 20000</li> </ul>
<b>Airflow Setpoint</b>	AI350 (R)	Measured (calibrated) airflow: <ul style="list-style-type: none"> <li>Units = CFM</li> <li>Min = 0</li> <li>Max = 10000</li> </ul>
<b>Damper Override</b> Force the damper to a selected position during balancing	MV172 (R/W)	<b>0 None (Default)</b> No damper override. Damper under normal control.
		<b>1 Min. flow</b> Force damper to maintain minimum airflow setpoint
		<b>2 Max. cool</b> Force damper to maintain maximum cooling airflow setpoint
		<b>3 Close</b> Force damper closed
		<b>4 Reheat</b> Force damper to maintain maximum reheat airflow setpoint
		<b>5 Open</b> Force damper fully open
<b>Balometer</b> This measured value will be used to update the calibration Offset and ensure the measured Airflow level matches the Balometer reading.		Measured airflow from Balometer: <ul style="list-style-type: none"> <li>Units = CFM</li> <li>Min = 0</li> <li>Max = 20000</li> </ul>
<b>Minimum Airflow Offset</b> Calibration offset applied to Airflow Level at Minimum flow	AV258	Measured airflow from Balometer: <ul style="list-style-type: none"> <li>Units = CFM</li> <li>Min = 0</li> <li>Max = 20000</li> <li>Default = 0</li> </ul>
<b>Maximum Airflow Offset</b> Calibration offset applied to Airflow Level at Maximum flow	AV259	Measured airflow from Balometer: <ul style="list-style-type: none"> <li>Units = CFM</li> <li>Min = -5000</li> <li>Max = 5000</li> <li>Default = 0</li> </ul>

## 10.2 PRESSURE DEPENDENT

Before starting to Balance the system, check the following parameters are correctly configured in the Configuration menu:

- VAV Box Type
- Actuator Type
- Floating Actuator Time

Airflow Balancing settings can be found on the Balancing page of the Setup menu.

The recommended process for Balancing the system is:

1. On page “Balancing (PD)”, set the approximate damper positions for Minimum, Maximum Cooling, Maximum Heating, Maximum Reheat.
2. For each position, repeat the following process:
  - a. Set the Damper Override to the desired position (Minimum, Maximum Cooling, Maximum Heating or Maximum Reheat).
  - b. Allow time for the damper to reach a defined position.
  - c. Take a reading of the actual airflow using a calibrated Balometer.
  - d. Compare actual airflow to the desired airflow and adjust the Damper Position accordingly.
  - e. Repeat until the measured airflow at the damper position matches the desired airflow.
3. On page “Balancing (PD)”, revert the Damper Override to None to allow the system to return to normal operation.

### BALANCING OPTIONS

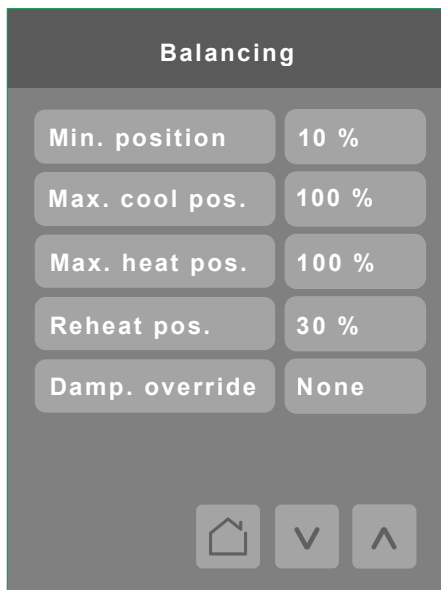

Pressure Independent		
Configuration parameter	BACnet	Function description
<b>Minimum Position</b>	AV250 (R/W)	Minimum damper position: <ul style="list-style-type: none"> <li>• Units = %</li> <li>• Min = 0</li> <li>• Max = 100</li> </ul>
<b>Maximum Cooling Position</b>	AV251 (R/W)	Maximum damper position during cooling: <ul style="list-style-type: none"> <li>• Units = %</li> <li>• Min = 0</li> <li>• Max = 100</li> </ul>
<b>Maximum Heating Position</b>	AV252 (R/W)	Maximum damper position during heating: <ul style="list-style-type: none"> <li>• Units = %</li> <li>• Min = 0</li> <li>• Max = 100</li> </ul>

Pressure Independent		
Configuration parameter	BACnet	Function description
<b>Reheat Position</b>	AV253 (R/W)	Damper position during reheating: <ul style="list-style-type: none"> <li>• Units = %</li> <li>• Min = 0</li> <li>• Max = 100</li> </ul>
<b>Damper Override</b> Force the damper to a selected position during balancing	MV172 (R/W)	<b>0 None (Default)</b> No damper override. Damper under normal control.
		<b>1 Min. flow</b> Force damper to maintain minimum airflow setpoint
		<b>2 Max. cool</b> Force damper to maintain maximum cooling airflow setpoint
		<b>3 Close</b> Force damper closed
		<b>4 Reheat</b> Force damper to maintain maximum reheat airflow setpoint
		<b>5 Open</b> Force damper fully open

## APPENDIX A. DEPLOYMENT

The placement of the Room Controller must be given consideration. It is recommended to install the Room Controller as close to a door as possible (without being blocked by the door), or in an area with high occupant movement.

Ideally, the Room Controller should be installed 5 feet (1.5 meters) above the floor surface to ensure maximum detection range is achieved. As well, Room Controller placement should ensure the occupant crosses the lens beam in a perpendicular path within the prescribed detection zone.

### A.1 EXAMPLE OF RECOMMENDED DEPLOYMENT

The below shows Room Controllers installed in ideal locations for two rooms.

The examination room shows one Room Controller installed adjacent to the door. In this area of the room, occupant traffic is high and ensures the occupant will almost always cross the PIR detection path laterally and within the detection range.

The waiting room shows one Room Controller installed beside a door in the middle of the room. As shown in the diagram below, occupant traffic is high in several areas of the room including the entrance, waiting room, access to the door and activity around the reception desk.

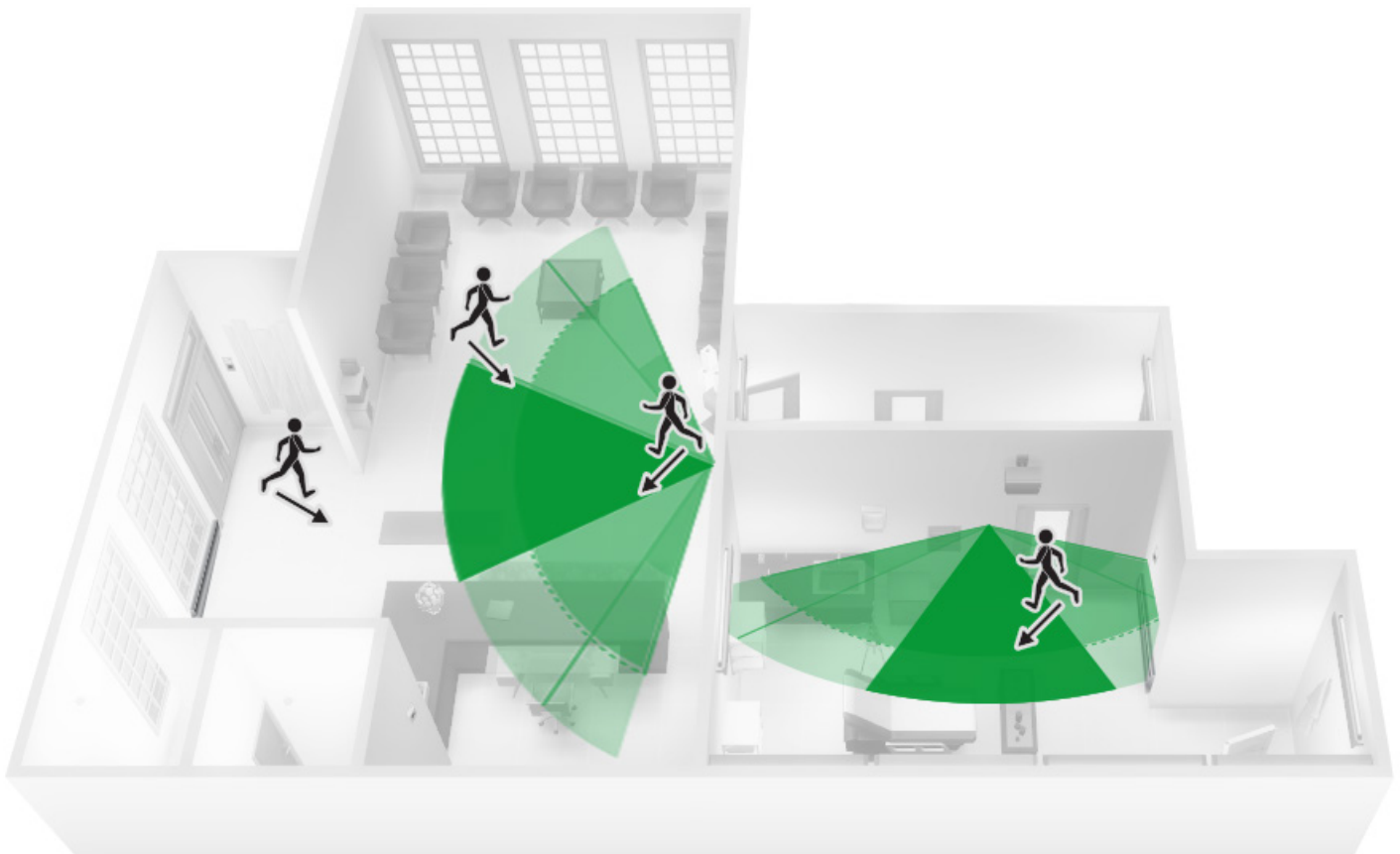

Recommended Installation

## A.2 EXAMPLE OF NON-RECOMMENDED DEPLOYMENT

The below shows four Room Controllers (two for each room) installed in non-ideal locations for the two rooms.

The examination room shows one Room Controller installed in a low traffic area near the door, and a second Room Controller installed on the wall directly opposite the door. For the Room Controller installed in the corner wall, the PIR could be blocked by the opened door, while occupant traffic could also be minimal in this area of the room. For the second Room Controller installed opposite the door, the PIR detection could fall outside the specified detection zone, while at the same time most occupant movement would not be lateral to the PIR, thereby not respecting optimal crossing patterns for PIR detection.

The waiting room shows one Room Controller installed in the corner of the room, and a second Room Controller installed beside the reception area. For the Room Controller installed in the corner, the opening/closing of the door creates a high probability that the PIR would get blocked, and therefore, occupancy going undetected. For the Room Controller installed beside the reception area, occupant traffic could fall outside the detection zone, and the receptionist would often be below the 5-foot recommended installation height for the Room Controller.

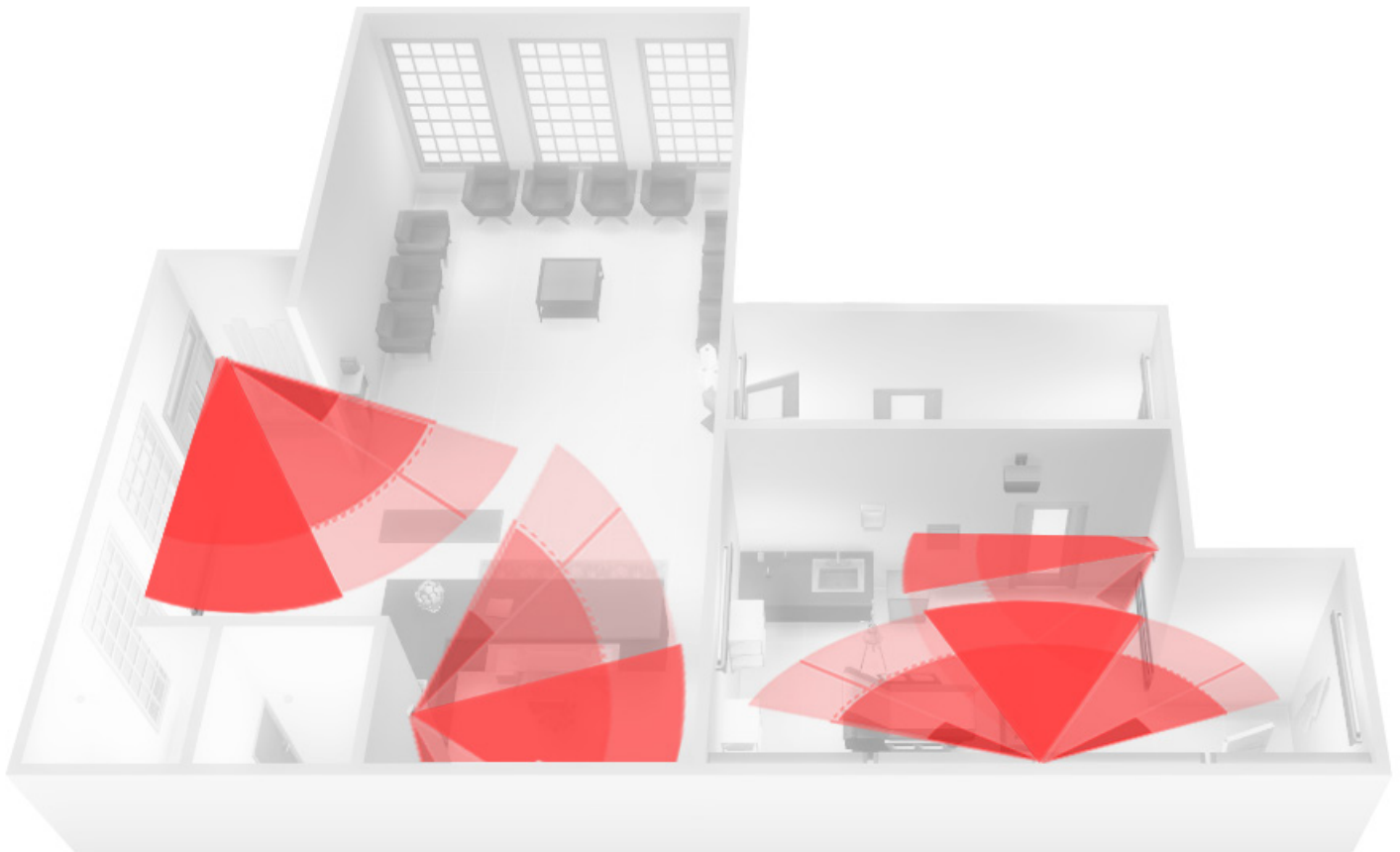

Non-Recommended Installation

### A.3 ROOM CONTROLLER PIR SENSOR DETAILS

The internal Room Controller PIR sensor only detects lateral movement. It cannot detect movement when a person is moving toward it. It will not detect someone seating on a chair and/or lying on the bed.

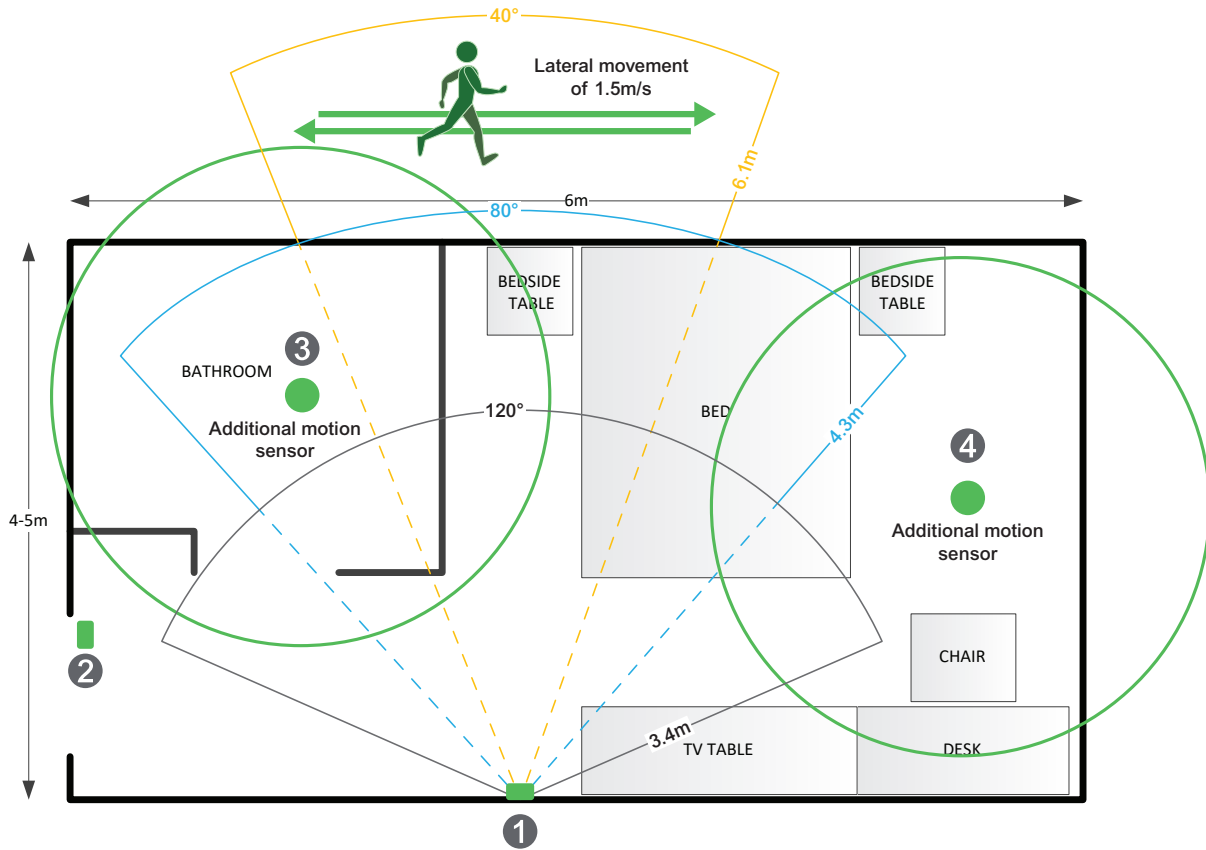

### A.4 RECOMMENDATIONS FOR INSTALLATIONS

1. Install the Room Controller to cover more lateral movement.
2. Install a door sensor, the internal Room Controller occupancy logic works better with a door sensor. Once a motion is detected after a door is opened, the room stays in an occupied state until the door is opened again which puts the Room Controller in stand-by mode and if there is a motion then it goes back in occupied mode. It is also recommended to disable the unoccupied mode, set the “unoccupied time” to 0, so there are only 2 modes in the Room Controller: stand-by and occupied for a stand-alone solution. Please refer to the two(2) diagrams below for the Room Controller internal occupancy states transition.

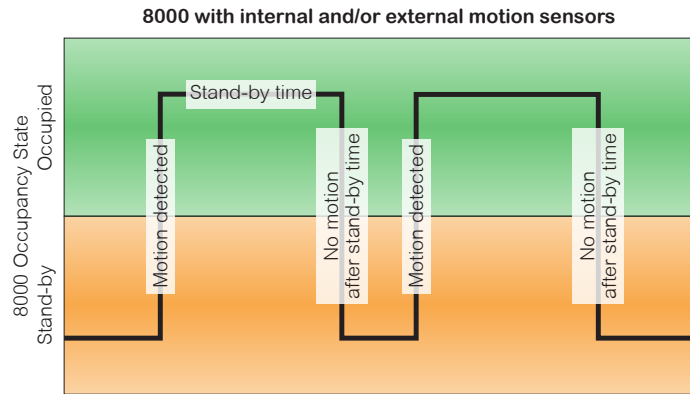

More aggressive energy savings logic but may cause a bad guest experience (when a guest is sleeping or not moving)

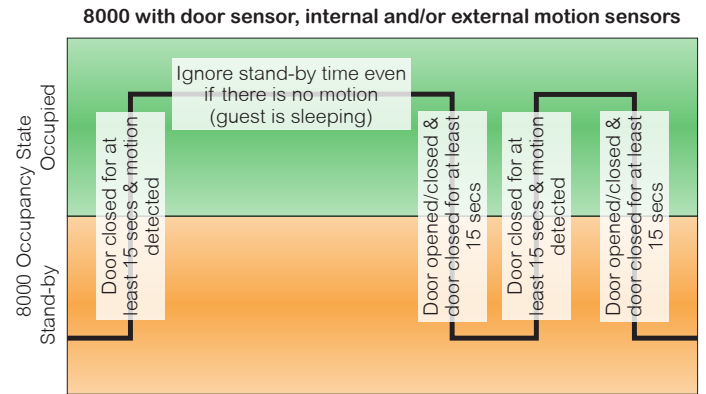

Good energy savings logic and better guest experience even when a guest is sleeping or not moving

3. Install additional motion sensors in the bathroom.
4. Install additional motion sensors for better motion detection in the entire room.

### A.5 ENERGY SAVINGS

PIR can maximize your energy saving from 10-30% by adjusting temperature set points in unoccupied zones during scheduled periods.

PIR can maximize your energy saving from 10-30% by adjusting temperature set points in unoccupied zones during scheduled periods.

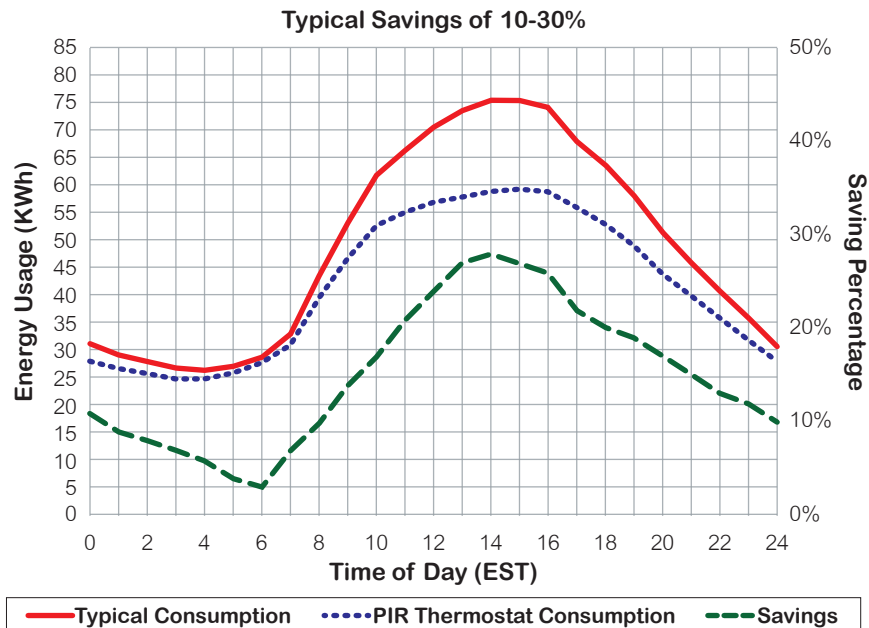

### APPENDIX B. CALIFORNIA PROPOSITION 65 WARNING STATEMENT FOR CALIFORNIA RESIDENTS

**⚠ WARNING:** This product can expose you to chemicals including Lead, which is known to the State of California to cause cancer and birth defects or other reproductive harm, and Bisphenol A (BPA), which is known to the State of California to cause birth defects or other reproductive harm. For more information, go to [www.P65Warnings.ca.gov](http://www.P65Warnings.ca.gov).



